

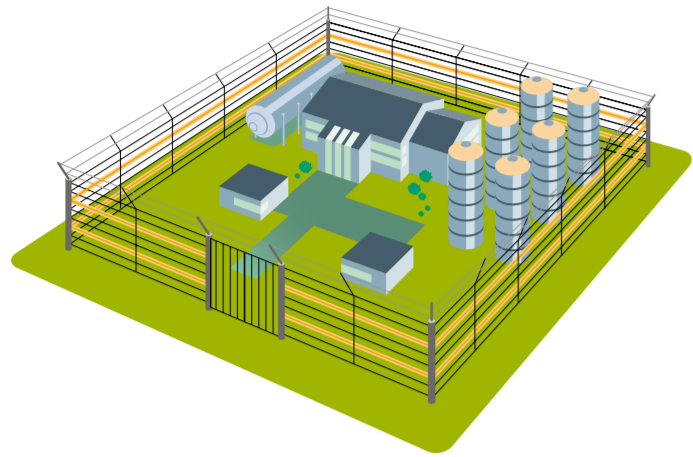

Outdoor protection perimeter overview

Integrated security solutions



Accessories



DF950-CM Universal Configuration Module (UCM) Software kit with interface cable

DF800 FlexZone cable splice kit

DF215 Outdoor sensor cable for FlexZone, 150 m



DF962 Quick disconnect gate assembly kit

DF963 Gate Bypass Module, Locally Activated by Keyswitch

DF410-420 Wireless gate sensor module, battery powered (DF410); Solar-powered, gray enclosure (DF420)

Applications

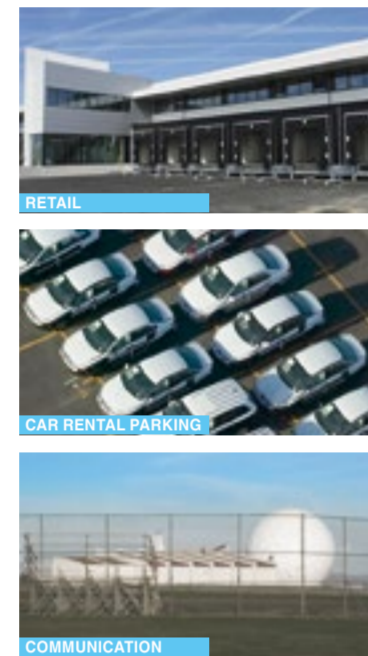

Fence, roof and wall protection

- DF104** FlexZone-4 processor in NEMA 4 aluminum enclosure. Provides up to 4 independent zones of detection. Includes mounting clamps.
- DF160** FlexZone-60 processor in NEMA 4 aluminum enclosure. Provides up to 60 independent zones of detection. Includes mounting clamps.
- DF215** FlexZone sensor cable, 150 m roll
- DF800** FlexZone cable splice kit
- DF801** FlexZone cable terminator
- DF860** Bag of 1000 UV resistant cable ties
- DF962** Gate disconnect assembly kit for sliding gates
- DF950-CM** UCM (Universal Configuration Module) kit, includes UCM software & FlexPS/FlexPI/FlexZone product documentation on CD plus a USB interface cable for UCM SW
- DF501** Mini network interface unit (USB to RS-422 & MMFO), DIN-rail mount
- DF502** Mini Network Interface Unit (USB to RS-422 & SMFO), DIN-rail mount
- DF955-SW** Network Manager service version on CD
- DF400** UltraLink processor module with 8/8 relay outputs/inputs. DIN-rail mount
- DF432** UltraLink expansion module, 32 relay
- DF205** UltraLink link extension cable, 58 cm (23 in)
- DF648** DIN rail DC power supply for ultraLink I/O modules. 24 VDC, 40W, 85 – 264 VAC 47 – 64 Hz input, DC OK relay
- DF410** Wireless gate sensor module, battery-powered, gray enclosure
- DF420** Wireless gate sensor module, solar-powered, gray enclosure
- DF955-series (C1-C5)** Single/ Multi-mode/ fiber optic (MMFO) / Ethernet communication cards



Outdoor motion sensors

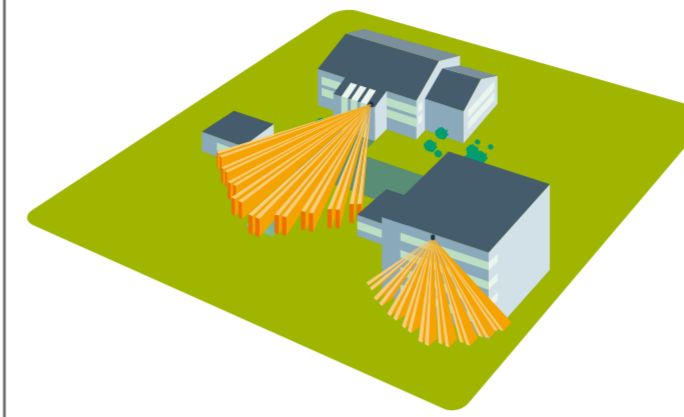

Accessories



DI601-WT Walk tester for DI601 and DDI602 series

6930AMP-SB Swivel bracket for outdoor curtain detector 6930AMP series



6932AMP-SB Swivel bracket – white

6932AMP-TB T-bracket – white

Applications

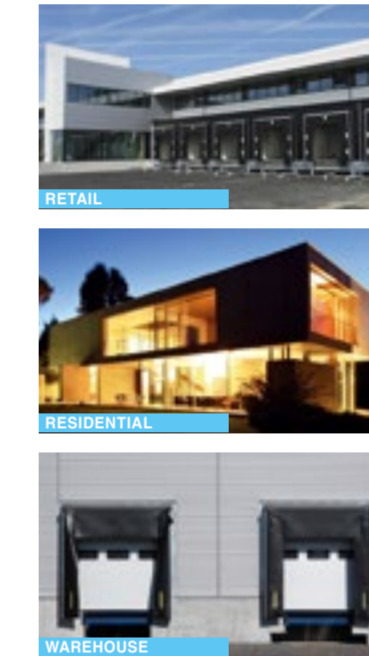

Wired Sensors

DI601 and DDI602 series

- PIR Technology**
- DI601** Outdoor PIR 10/20/30m selectable
- DI601AM** Outdoor PIR/AM 10/20/30m selectable – Anti-masking

DUAL Technology

- DD2-F1** Outdoor dual technology detector 10.525 GHz 10/20/30 m - 33/66/98 ft selectable
- DDI602AM-F1** Outdoor dual technology detector 10.525 GHz 10/20/30 m - 33/66/98 ft selectable – Anti-masking
- DDI602-F2** Outdoor dual technology detector 10.587 GHz 10/20/30 m - 33/66/98 ft selectable
- DDI602AM-F2** Outdoor dual technology detector 10.587 GHz 10/20/30 m - 33/66/98 ft selectable – Anti-masking
- DDI602-F3** Outdoor dual technology detector 9.9 GHz 10/20/30 m - 33/66/98 ft selectable
- DDI602AM-F3** Outdoor dual technology/AM detector 9.9 GHz 10/20/30 m selectable – Anti-masking

Accessory

- DI601-WT** Walk tester for DI601 and DDI602 series

Curtain Outdoor and Mini Outdoor

- 6930AMP** Outdoor curtain detector dual/AM (10.525GHz)
- 6931AMP** Outdoor curtain detector dual/AM (10.587GHz)
- 6933AMP** Outdoor curtain detector dual/AM (10.587 GHz) – white

Mini outdoor

- 6910P** Mini outdoor PIR
- 6920P** Mini outdoor motion sensor – dual technology (10.525 GHz)
- 6921P** Mini outdoor motion sensor – dual technology (10.587 GHz)

Accessories

- 6930AMP-SB** Swivel bracket for outdoor curtain detector 6930AMP series
- 6932AMP-SB** Swivel bracket in white color
- 6932AMP-TB** T-bracket in white color

Wireless Sensors

- TX-2810**
- TX-2810-03-4** Wireless Outdoor PIR 868AM Gen2
- TX-2821-03-4** Wireless Mini Outdoor PIR 868AM Gen2

Outdoor microwave sensors

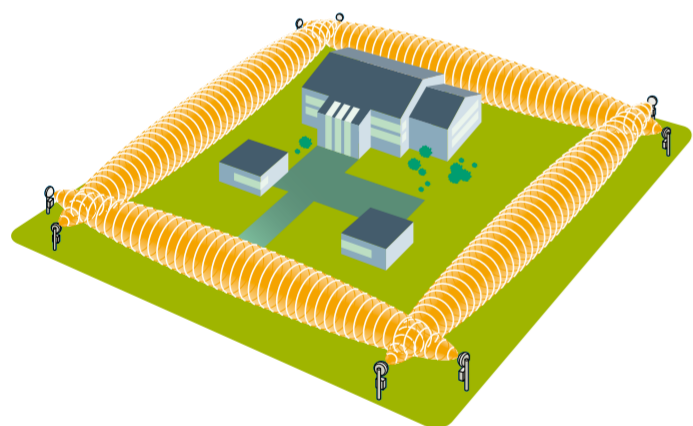

MRW Series

The Netherlands, Belgium, UK, Denmark, Sweden, Ireland, Poland, Norway, Finland

- MRW50-F1** Outdoor Microwave Motion Sensors, 10.5 GHz, 50 m
- MRW100-F1** Outdoor Microwave Motion Sensors, 10.5 GHz, 100 m
- MRW200-F1** Outdoor Microwave Motion Sensors, 10.5 GHz, 200 m

France, Austria, Portugal, Czech Republic

- MRW50-F2** Outdoor microwave motion sensors, 9.9 GHz, 50 m
- MRW100-F2** Outdoor microwave motion sensors, 9.9 GHz, 100 m
- MRW200-F2** Outdoor microwave motion sensors, 9.9 GHz, 200 m

Spain, Luxembourg

- MRW50-F4** Outdoor microwave motion sensors, 10.525 GHz, 50 m
- MRW100-F4** Outdoor microwave motion sensors, 10.525 GHz, 100 m
- MRW200-F4** Outdoor microwave motion sensors, 10.525 GHz, 200 m

Accessories

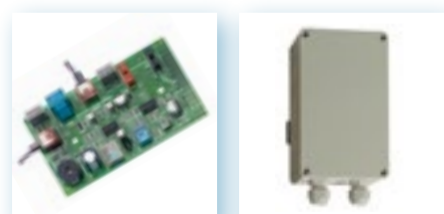

MRW01 Alignment tool

MRW02-N Power supply 230 VAC/19 VAC with IP66 enclosure



MRW03 Pair of inox poles 120cm

BS122N Sealed Lead-Acid Battery 12V 2.2Ah

Applications

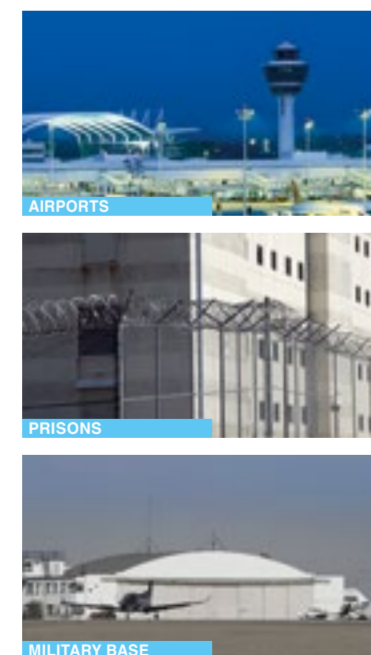

Active infrared beams

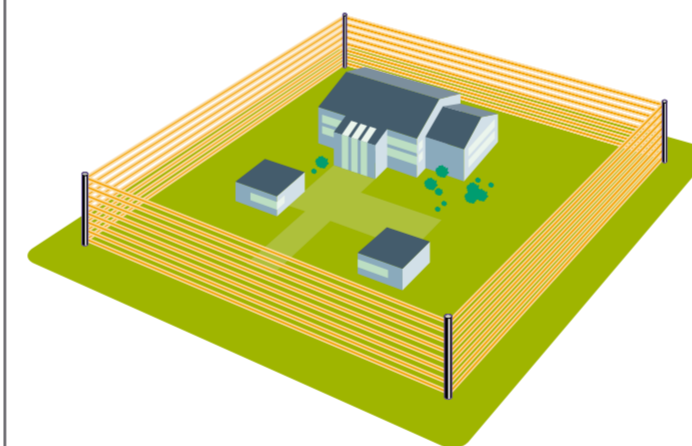

Accessories



SB11/16/21/26/31 Kit for 2-sided view

SB53 Socket for SB series pillar

SB18 AIR Pillar climbing detector

PB50-H 12V non polarity heater 250mA for beam tower



PB50-T Thermostat for beam tower

PB50-AC180 Anti climb top tamper for 180°/360° beam towers

PB50-AC360 Anti climb top tamper for 180°/360° beam towers

SB52 Power Supply 230VAC to 12VAC & 12VDC

BS121N Sealed Lead-Acid Battery 12V 1.2Ah VdS approved

Applications

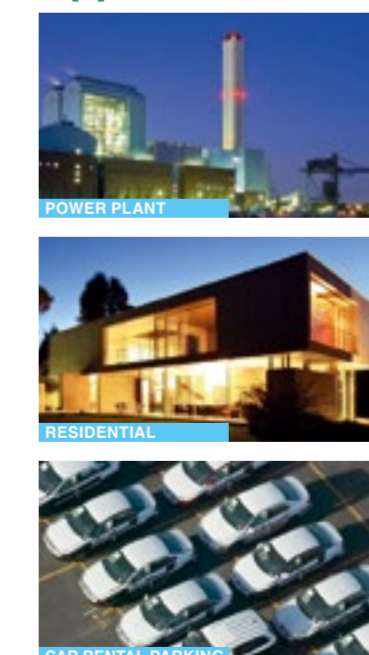

SB series

Beams

- SB250-N** AIR stand alone twin beam, 50 m range
- SB2100-N** AIR stand alone twin beam, 100 m range
- SB450-N** AIR stand alone quad beam, 50 m range
- SB4100-N** AIR stand alone quad beam, 100 m range
- SB4200-N** AIR stand alone quad beam, 200 m range

Pillars

- SB10** Empty pillar 1 m
- SB15** Empty pillar 1.5 m
- SB20** Empty pillar 2 m
- SB25** Empty pillar 2.5 m
- SB30** Empty pillar 3 m

PB series

Beams

- PB501** Twin AIR beam 20 m outdoor/40 m indoor
- PB511** Twin AIR beam 40 m outdoor/80 m indoor
- PB521** Twin AIR beam 60 m outdoor/120 m indoor
- PB601** Outdoor quad AIR beam 50 m
- PB611** Outdoor quad AIR beam 100 m
- PB621** Outdoor quad AIR beam 200 m

Pillars

- PB10** 1 m – 180° AIR beam tower
- PB15** 1.5 m – 180° AIR beam tower
- PB20** 2 m – 180° AIR beam tower
- PB30** 3 m – 180° AIR beam tower
- PB11** 1 m – 360° AIR beam tower
- PB16** 1.5 m – 360° AIR beam tower
- PB21** 2 m – 360° AIR beam tower
- PB31** 3 m – 360° AIR beam tower