



TruVision HD-TVI (1080P) / Analog Wedge Camera Installation Guide

TVW-6101

P/N 1073422-EN • REV C • ISS 06JUL21

Content

Product overview	2
Contact information and manuals/tools/firmware	2
Package contents	3
Camera description	6
Installation	7
Program	14
Using a TVI output	15
Call up the camera OSD (On Screen Display) menu	15
Menu tree	18
Video format (NTSC/PAL)	19
Specifications	19
Legal and Regulatory information	20

Product overview

This is the Installation Guide for the HD-TVI (1080P) / analog wedge camera TVW-6101. This guide describes a standard installation.

The configuration manual is available from our web site.

Contact information and manuals/tools/firmware

For contact information and to download the latest manuals, tools, and firmware, go to the web site of your region.

EMEA: <https://firesecurityproducts.com>

Manuals are available in several languages.

Australia /
New
Zealand: <https://firesecurityproducts.com.au/>

Package contents

- Camera assembly (cable harness not shown)

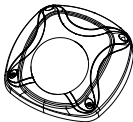

- 3 M4 x 25 mm screws and 3 anchors for wall or ceiling installation

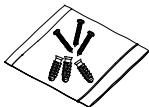

- Camera drill template

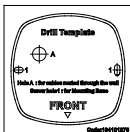

- 2 screws M4 x 8 used for installing the camera to the adapter plate



- Torx wrench



- Adapter plate

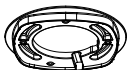

- Adapter plate drill template

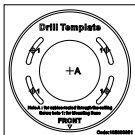

- 12 VDC connector (2 terminal connectors with positive and negative indicators)



- Lens adjustment tool



- Installation guide

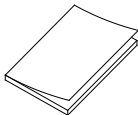

- Equipment disposal sheet

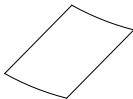

Camera description

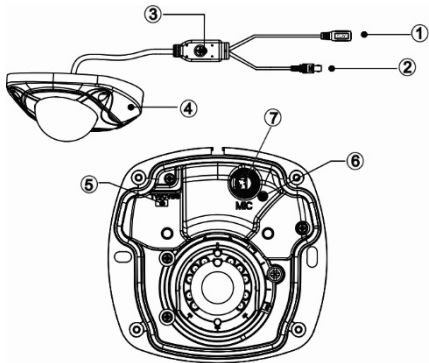

- | | | | |
|----|--------------------------------|----|---------------------------|
| 1. | 12 VDC power cable | 5. | TVI / 960H analog switch |
| 2. | TVI / 960H analog video output | 6. | Power LED |
| 3. | OSD menu button | 7. | MIC (Audio not supported) |
| 4. | Camera housing | | |

Note: When using the HD-TVI output, the HD-TVI wedge camera should only be connected to a DVR that supports a TVI signal.

Installation

To install the camera on a surface:

1. Use the camera drill template to mark the mounting holes.

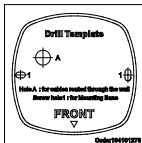

2. Follow all local safety regulations. Drill through the mounting surface. If you need to route the cables from the bottom of the camera, drill a larger hole in the mounting surface for the cable harness.
3. Using the Torx wrench, loosen the four screws to remove the housing cover from the device.

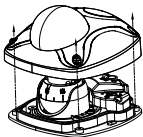

4. Install the mounting base to the surface using two of the M4 x 25 mm screws and anchors. If routing the cable harness through the ceiling, do so prior to mounting the camera.



5. Loosen the Philips screw, located near the lens assembly. Align the lens adjustment tool with the two small holes located on the camera assembly.

Rotate (pan) the camera assembly using the lens adjustment tool until the lens is positioned

in the correct location. The tool is also used to adjust the tilt angle.

Philips screw

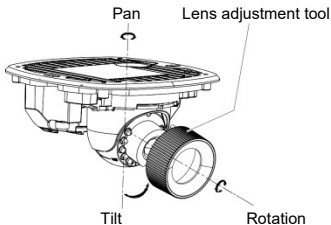
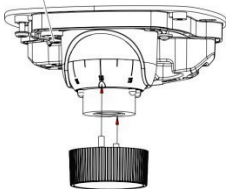

Note: Please do not remove the foam ring attached to the lens. This foam ring is required to reduce the glare of IR illuminators.

6. Tighten the Torx screw and re-install the housing cover to the camera assembly using the Torx wrench.

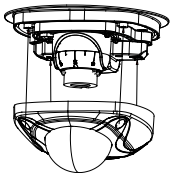

To install the camera using the adapter plate:

1. Use the adapter plate drill template to mark the holes.

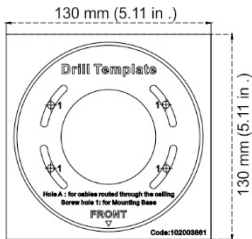

2. Follow all local safety regulations. Drill through the mounting surface. If you need to route the cables from the bottom of the camera, drill a larger hole for the cable harness.
3. Install the adapter plate to the using two of the M4 x 25 mm screws and anchors.

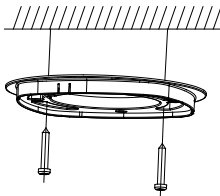

- Using the Torx wrench, loosen the four screws to remove the housing cover from the device.

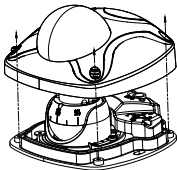

- Install the camera base to the adapter plate using the two M4 x 8mm screws.

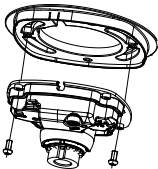

- Loosen the Philips screw located near the lens assembly. Align the lens adjustment tool with the two small holes located on the camera assembly.

Rotate (pan) the camera assembly using the lens adjustment tool until the lens is positioned in the correct location. The tool is also used to adjust the tilt angle.

Philips screw

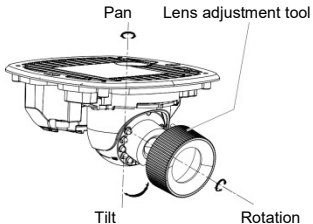
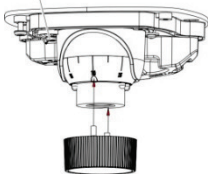

Note: Please do not remove the foam ring attached to the lens. This foam ring is required to reduce the glare of IR illuminators.

7. Tighten the Philips screw and re-install the housing cover to the camera assembly using the Torx wrench.

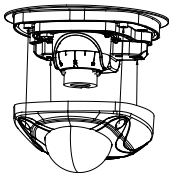

Program

In HD-TVI or Analog mode, use the OSD (On Screen Display) button to program the camera. The button is located on the cable harness. In HD-TVI mode, the OSD menu can also be accessed via the TVI recorder.

Using a TVI output

Once the camera has been installed, you can configure the camera settings on the TVI DVR.

Connect the TVI cable to the DVR, as shown.

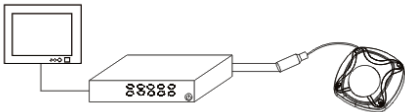

Select the PTZ protocol **TruVision Coax** and click the **Menu** button to call up the camera menu.

For more details, refer to the TVI DVR user manual.

Call up the camera OSD (On Screen Display) menu

To set up the camera in HD-TVI mode:

1. In **Camera Settings** of the DVR, access the PTZ menu and select the *TruVision-Coax* protocol for the TruVision HD-TVI camera from the drop down menu.

2. In live view of the desired camera, click the PTZ Control icon on the live view toolbar to access the PTZ control panel.

3. To call up the camera setup menu:

From the camera OSD of the DVR, select **Menu**.

— or —

From the DVR, select **Iris+**.

The camera setup menu appears (see “Menu tree” on page 18 for the menu structure).

4. Select the menu options:

From the TVI recorder (HD-TVI mode): To select an OSD item, click the directional buttons up/down. To adjust the value of a selected item, click the directional buttons left/right.

From the camera (HD-TVI or Analog mode): The OSD button is located on the cable harness. To select an OSD item, push the **Menu** button up/down. To adjust the value of a selected item, push the **Menu** button left/right.

5. Click **Iris+** to enter the submenu or to confirm the selected item.
6. When the setup is complete, select **Exit** and click **Iris+** to exit the camera OSD.

Note: You cannot exit the camera setup menu using the Menu button on the camera.

Menu tree

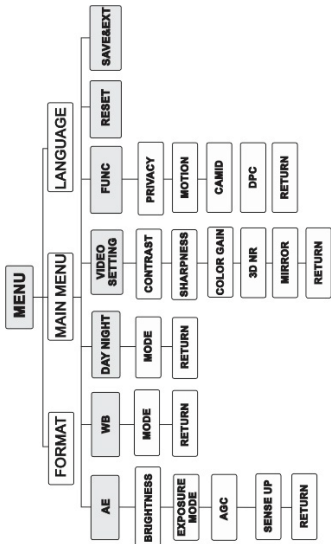

Video format (NTSC/PAL)

Under **Format**, select PAL or NTSC.

Specifications

Power supply	12 VDC
Current	290 mA max.
Power consumption	3.5 W max.
Operating temperature range	-40 to +60 °C (-40 to +140 °F)
Weight (net)	260 g (0.57 lb.)
Dimensions	99.5 x 97 x 46.8 mm (3.92 x 3.82 x 1.84 in.)

Legal and Regulatory information

Copyright:

© 2021 Carrier. All rights reserved. Specifications subject to change without prior notice.

This document may not be copied in whole or in part or otherwise reproduced without prior written consent from Carrier, except where specifically permitted under US and international copyright law.

Trademarks and patents:

TruVision names and logos are a product brand of Aritech, a part of Carrier.

Other trade names used in this document may be trademarks or registered trademarks of the manufacturers or vendors of the respective products.

Manufacturer:

PLACED ON THE MARKET BY:

Carrier Fire & Security Americas Corporation Inc.

13995 Pasteur Blvd, Palm Beach Gardens, FL 33418, USA

AUTHORIZED EU REPRESENTATIVE:

Carrier Fire & Security B.V.

Kelvinstraat 7, 6003 DH Weert, Netherlands

Certification:



FCC compliance: Class A

Class A: This equipment has been tested and found to comply with the limits for a Class A digital device, pursuant to part 15 of the FCC Rules. These limits are designed to provide reasonable protection against harmful interference when the equipment is operated in a commercial environment. This equipment generates, uses, and can radiate radio frequency energy and, if not installed and used in accordance with the instruction manual, may cause harmful interference to radio communications. Operation of this equipment in a residential area is likely to cause harmful interference in which case the user will be required to correct the interference at his own expense.

ACMA compliance

Notice! This is a Class A product. In a domestic environment this product may cause radio interference in which case the user may be required to take adequate measures.

Canada

This Class A digital apparatus complies with Canadian ICES-003. Cet appareil numérique de la classe A est conforme à la norme NMB-0330 du Canada.

European Union directives:

This product and - if applicable - the supplied accessories too are marked with "CE" and comply therefore with the applicable harmonized European standards listed under the EMC Directive 2014/30/EU, the RoHS Directive 2011/65/EU



2012/19/EU (WEEE directive): Products marked with this symbol cannot be disposed of as unsorted municipal waste in the European Union. For proper recycling, return this product to your local supplier upon the purchase of equivalent new equipment, or dispose of it at designated collection points. For more information see: www.recyclethis.info.

Contact information:

EMEA: <https://firesecurityproducts.com>

Australian/New Zealand: <https://firesecurityproducts.com.au/>

Product documentation:

Please scan the QR code to download the electronic version of the product documentation. The manuals are available in several languages.

