

TruVision TVD-CB2 Cup Base Installation Instructions

Dimensions

Dimensions:

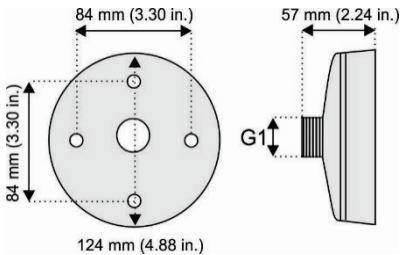

Weight: 200 g (7.02 oz.)

Accessories:

Screw A: 4 pcs

Used to attach the wedge adapter plate to the cup base.

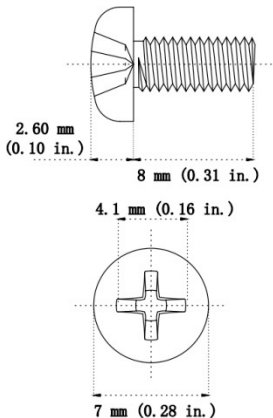

Supported devices

- TVW-1103/3103
- TVW-1104/3104
- TVW-1105/3105
- TVW-1106/3106
- TVW-1116/3116
- TVW-1130/3130
- TVW-2101/4101
- TVW-2401/4401
- TVW-5301
- TVW-5302
- TVW-5303
- TVW-5304
- TVW-5305
- TVW-5601
- TVW-5602
- TVW-5603
- TVW-5604
- TVW-5605
- TVW-6101
- TVD-SNB Swan Neck Wall Mount
- TVD-PPB Pendant Mount
- TVD-CBW Wall Mount

Installing a TVD-CB2 cup base to a wedge camera

When installing a TVD-CB2 cup base to a wedge camera, you require:

- TVD-CB2 cup base
- Mounting screw A (4 pcs.) for mounting the wedge adapter plate to the cup base.
- Mounting screws M4 x 8 (3 pcs.) for mounting the wedge camera to the wedge adapter plate, included with the camera.
- Wedge adapter plate, included with the wedge camera:

IP Series 1, IP Series 3, and Analog/TVI

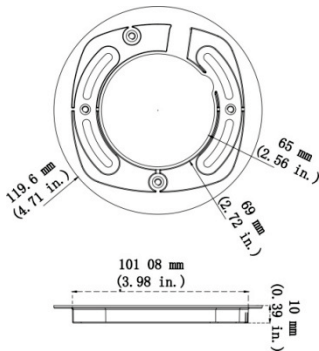

IP Series 6

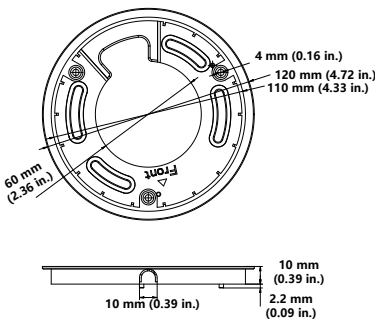

To mount a wedge camera to a TVD-SNB wall mount with a TVD-CB2 cup base:

1. Route the camera cables through the wall mount tube. Attach the swan neck wall mount to the wall using the expansion anchors that are provided with the swan neck mount.

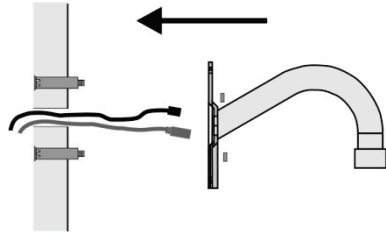

2. Using the four A screws, attach wedge adapter plate to the cup base.



3. Screw the cup base onto the swan neck wall mount and tighten with the locking screw.

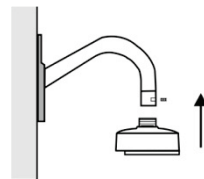

4. Loosen the screws on the wedge bubble assembly using the Torx wrench that is supplied with the camera and remove the enclosure.

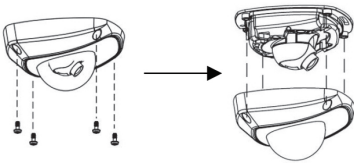

5. Connect the cables to the wedge camera. Using the mounting screws M4 × 8 (3 pcs.) that are supplied with the wedge camera, attach the camera base to the wedge adapter plate.

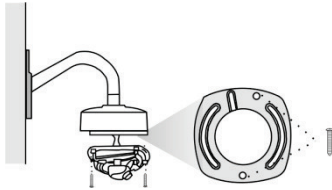

6. Reattach the wedge bubble assembly to the camera.

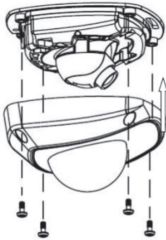

To mount a wedge camera to TVD-PPB pendant mount with a TVD-CB2 cup base:

1. Screw the pendant mounting plate onto the pendant mount pipe and tighten with the locking screw, as shown.

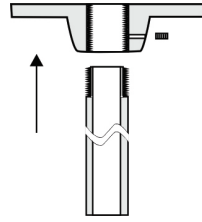

2. Route the camera cables through the pendant mount. Attach the mount to the ceiling with expansion anchors that are included with the pendant mount.

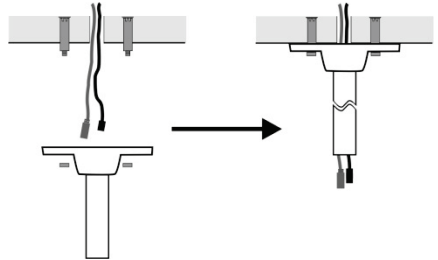

3. Using four screws that are included with the wedge camera, attach the wedge adapter plate to the cup base. Screw the cup base onto the pendant mount and tighten with the locking screw.

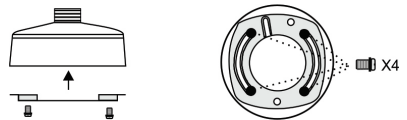

4. Loosen the screws on the wedge bubble assembly using the Torx wrench that is supplied with the camera and remove the enclosure.

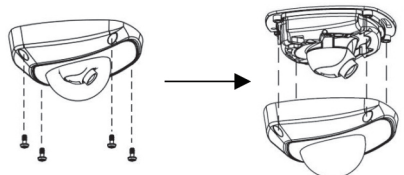

- Using the mounting screws M4 × 8 (3 pcs.) that are supplied with the wedge camera, attach the camera base to the wedge adapter plate.

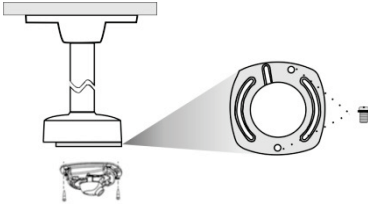

- Reattach the camera enclosure to the camera.

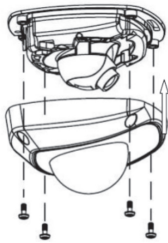

To mount a wedge camera to a TVD-CBW wall mount with a TVD-CB2 cup base:

- Route the camera cables through the wall mount. Attach the wall mount to the wall using the expansion anchors that are provided with the TVD-CBW.

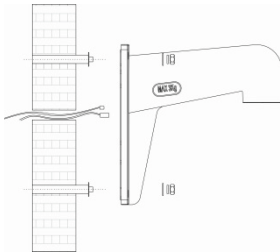

- Loosen the Torx screws with a Torx wrench (supplied with the

camera) to remove the bubble assembly.

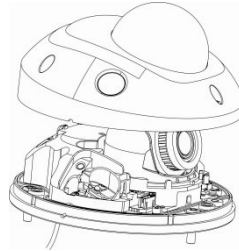

- Route the camera cables through the adapter plate.
- Screw the cup base onto the wall mount and tighten with the locking screw, as shown (A). Attach the camera adapter plate to the cup base (B) using screw A, routing the camera cables through the adapter plate.

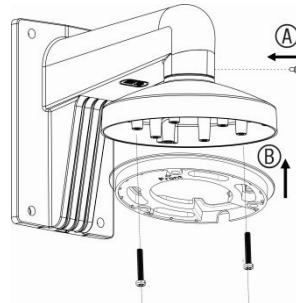

- Mount the camera base to the adapter plate using the mounting screws M4 × 8 (3 pcs.).

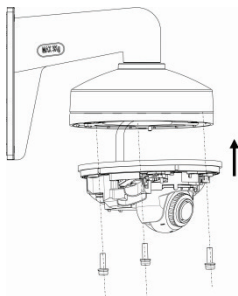

6. Reattach the bubble assembly to the camera base.

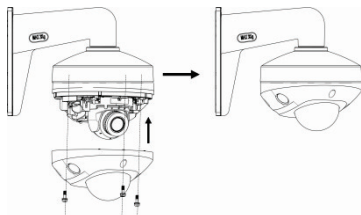

Legal and regulatory information

Copyright © 2021 Carrier. All rights reserved. Specifications subject to change without prior notice

Trademarks and patents TruVision names and logos are a product brand of Aritech, a part of Carrier

Certification



Contact information EMEA: <https://firesecurityproducts.com>
 Australian/New Zealand: <https://firesecurityproducts.com.au/>

Product documentation Please consult the following web link to retrieve the electronic version of the product documentation. The manuals are available in several languages.



