

# TVP-PAS Stainless Steel PTZ Pendant Mount Installation Instructions

## Specifications

**Dimensions:** 160 × 160 × 342 mm  
(6.30 × 6.30 × 13.46 in.)

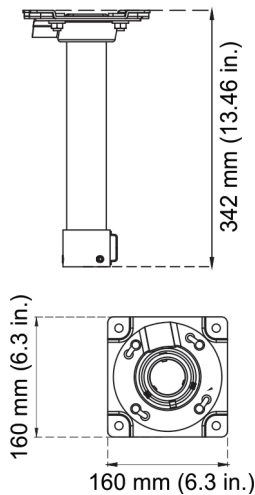

**Weight:** 1.89 kg (4.17 lbs.)

**Accessories:**

Drill template: 1 pcs

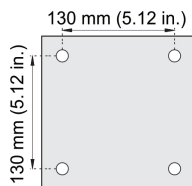

Mounting plate: 1 pcs

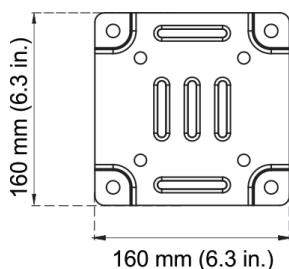

Expansion anchors: M10 x 80 mm (4 pcs)

Used to install the TVP-PAS stainless pendent mount to the mounting surface.

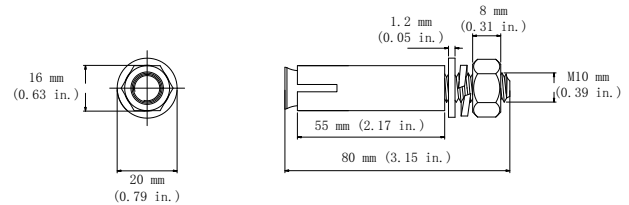

Nut (4 pcs), flat washer (4 pcs), and split washer (4 pcs) A

Used to mount the pipe assembly to the mounting plate

Nut:

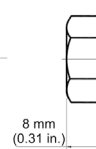
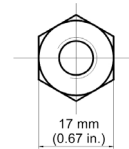

Flat washer:

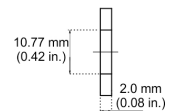
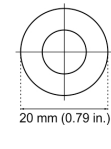

Split washer:

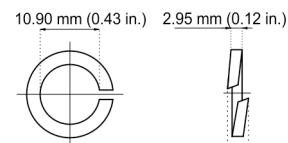

## Supported cameras

The stainless steel pendent mount can be used with following cameras:

Stainless Steel PTZ Dome:	TVP-5201
---------------------------	----------

## Installation

To install the stainless steel PTZ dome to the TVP-PAS:

- Using the drill template mark the mounting surface. Drill four mounting holes and insert the expansion anchors.
- Secure the mounting plate to the mounting surface using the expansion anchors.

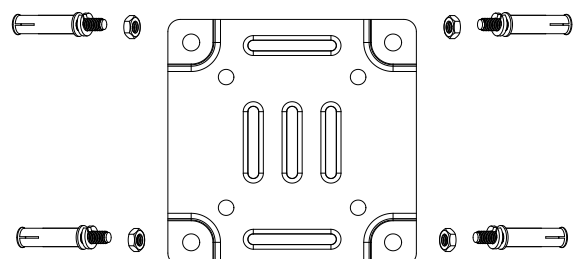

3. Route the PTZ cable assembly through the pendant mount pipe.
4. Using the hex wrench that is included with the stainless steel PTZ, loosen the two hex head screws (2) on the pipe (see figure in step 6).
5. To install the PTZ to the pendant mount, line up the flat section of the metal ring (cable harness) at the top of the PTZ with the safety lanyard screw on the pendant mount. Once the PTZ is up against the end of the pendant mount, rotate the PTZ 45 degrees. Tighten down the two hex screws to secure the PTZ in place.
6. Attach the safety lanyard (1) between the PTZ and the pendant mount.

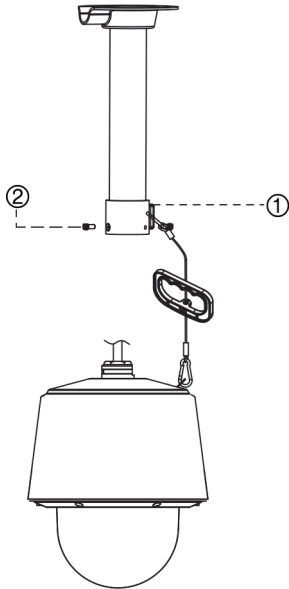

7. Align the mounting base of the pendant mount with the standoffs on the mounting plate. Rotate the pendant mount base/pipe in the direction shown to lock the assembly in place. Use the nut and washers A to secure the pipe to the mounting plate.

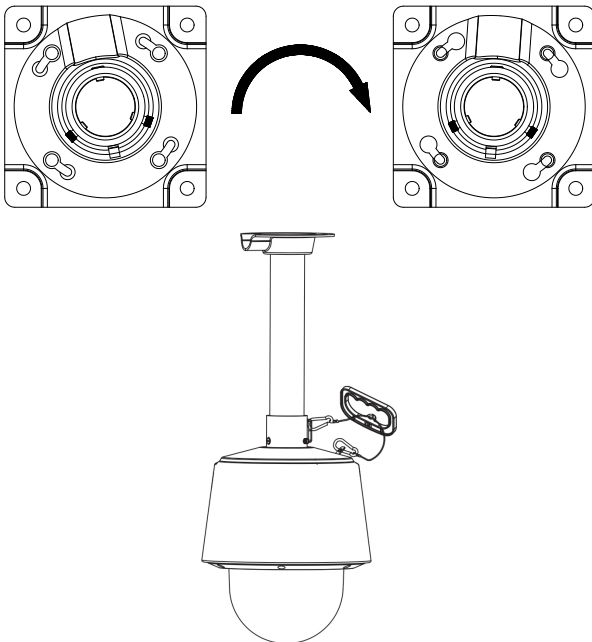

## Legal and regulatory information

Trademarks and patents	The trade names used in this document may be trademarks or registered trademarks of the manufacturers or vendors of the respective products.
Manufacturer	Interlogix. 2955 Red Hill Avenue, Costa Mesa, CA 92626 5923, USA Authorized EU manufacturing representative: UTC Fire & Security B.V. Kelvinstraat 7, 6003 DH Weert, The Netherlands

### Certification



### Product warnings and disclaimers

THESE PRODUCTS ARE INTENDED FOR SALE TO AND INSTALLATION BY QUALIFIED PROFESSIONALS. UTC FIRE & SECURITY CANNOT PROVIDE ANY ASSURANCE THAT ANY PERSON OR ENTITY BUYING ITS PRODUCTS, INCLUDING ANY "AUTHORIZED DEALER" OR "AUTHORIZED RESELLER", IS PROPERLY TRAINED OR EXPERIENCED TO CORRECTLY INSTALL FIRE AND SECURITY RELATED PRODUCTS.

For more information on warranty disclaimers and product safety information, please check [www.firesecurityproducts.com/policy/product-warning/](http://www.firesecurityproducts.com/policy/product-warning/) or scan the following code:



### Contact information and manuals

For contact information go to: [www.interlogix.com](http://www.interlogix.com) or [www.firesecurityproducts.com](http://www.firesecurityproducts.com)

To get translations for this and other product manuals go to: [www.firesecurityproducts.com](http://www.firesecurityproducts.com)